

# UGELLI AIRLESS

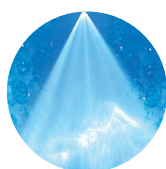

**euspray**®

by Eurospray spray and filter technology SL

## UGELLI A GETTO PIATTO "AIRLESS" MODELLO "TC"

### Caratteristiche

Tutti gli ugelli della serie "Airless" presentano inserti in carburo di tungsteno di altissima qualità che garantiscono la massima resistenza alla abrasione e distribuzione uniforme.

Consigliamo di verificare l'usura degli ugelli per sostituirli al momento corretto e non avere una spesa economica dovuta alla scarsa efficienza dell'impatto del getto.

Tutti gli ugelli presentano marcatura laser secondo nostro standard, marcature speciali devono essere richieste in fase d'ordine.

### Materiali

Corpo: Aisi303

Inserto: carburo di tungsteno

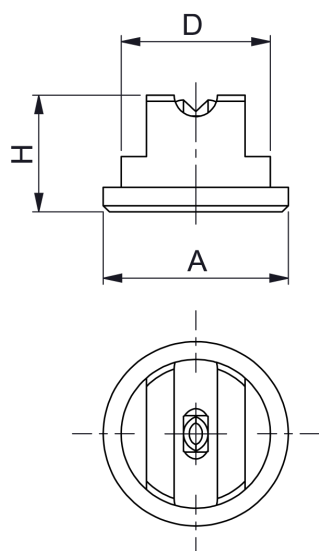

#### DIMENSIONI BASSO (S)

H = 9,5mm  
D = 10,3 mm  
A = Ø = 15 mm

#### DIMENSIONI ALTO (L)

H = 12,5 mm  
D = 10,3 mm  
A = Ø = 15 mm



Fattore Portata	Diam. Orifizio (mm)	Angoli di spruzzo disponibili <°							Portate (lpm) a differenti pressioni (bar)			Tipo di Corpo
		40	50	65	80	95	110	130	50	100	150	
0017	0,28			●		●			0,28	0,39	0,48	S
0025	0,33			●	●	●	●		0,40	0,57	0,70	S
0033	0,38			●	●	●	●		0,53	0,75	0,92	S
0039	0,41			●	●	●	●		0,63	0,89	1,09	S
0044	0,43			●					0,71	1,00	1,20	S
0050	0,46			●			●		0,78	1,10	1,35	S
0067	0,53			●	●	●	●		1,06	1,50	1,84	S
0080	0,58			●	●	●	●		1,27	1,80	2,20	S
01	0,66			●	●	●	●		1,63	2,30	2,82	S
015	0,79			●	●	●	●	●	2,40	3,40	4,16	S
02	0,91			●	●	●	●	●	3,25	4,60	5,63	S
03	1,10		●	●	●	●	●	●	4,81	6,80	8,33	L
04	1,30			●	●	●	●	●	6,43	9,10	11,15	L
05	1,40			●	●	●	●	●	8,06	11,40	13,96	L
06	1,60	●	●	●	●	●	●	●	9,69	13,70	16,78	L
07	1,70			●	●	●	●		11,31	16,00	19,60	L
08	1,80			●	●	●	●	●	12,87	18,20	22,29	L
09	1,90			●	●		●		14,85	21,00	25,72	L
10	2,00						●		16,10	23,00	28,00	L
12	4,30						●		19,30	27,00	33,00	L

**Come Ordinare**

Esempio: ugello TC con le seguenti caratteristiche: portata 4,6 lpm a 100 Bar e angolo di spruzzo di 65°, diametro orifizio 0,91 mm

MODELLO	FATTORE DI PORTATA	ANGOLO DI SPRUZZO	TIPO DI CORPO	CODICE
TC	02	6	S	<b>TC026S</b>

Si prega di contattare Euspray per la corrispondenza tra angoli di spruzzo e codice dell'angolo.

**Accessori**

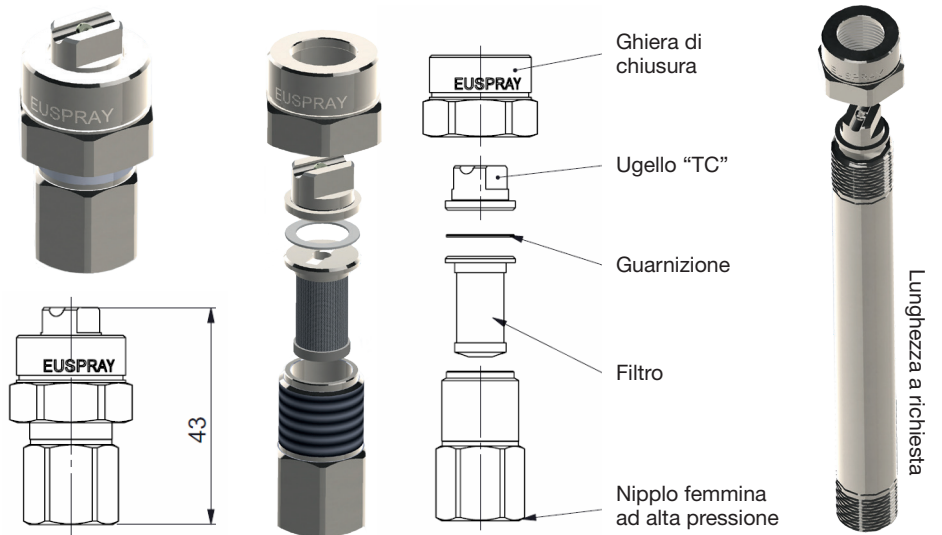

**Ugelli per aria compressa**

**A41WJ**

Materiale: Aisi304 o Aisi316  
Connessione: 1/4" BSPT

**P1WJ**

Materiale: Polipropilene  
Connessione: 1/4" BSPT



**A41WJ**

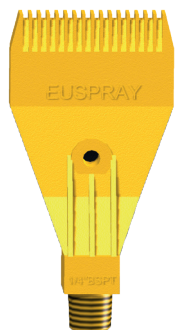
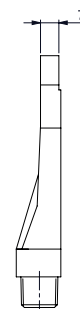
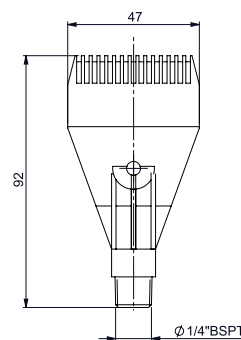

**P1WJ**

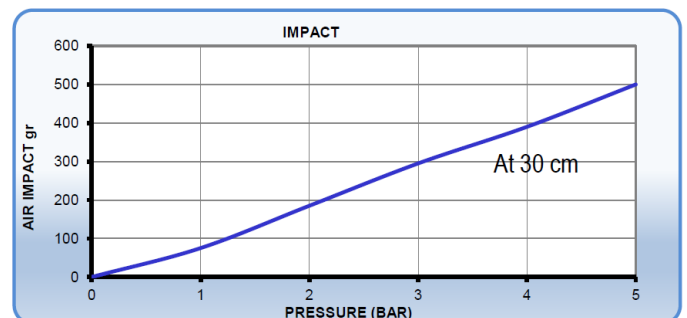
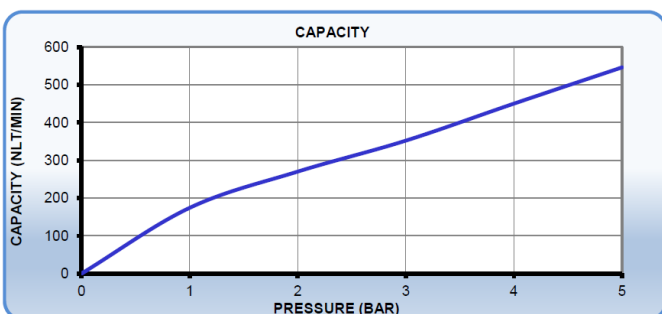

We are present in the following Countries



- Australia
- Austria
- Chile
- Egypt
- France
- Germany
- Greece
- India
- Indonesia
- Ireland
- Italy
- Lituania
- Poland
- Czech Republic
- Russia
- Singapore
- Slovakia
- South Africa
- Turkey
- Ukraine



**Euspray**  
Calle Narcís Monturiol, Num.14 , 4º 1ª  
08960 Sant Just Desvern - Barcelona  
Tel. +34 934773846

[www.euspray.com](http://www.euspray.com)

**Sales department**  
Italy: [commerciale@fmsrl.eu](mailto:commerciale@fmsrl.eu)  
Spain: [comercial@euspray.com](mailto:comercial@euspray.com)  
Rest of the world: [export@euspray.com](mailto:export@euspray.com)